

- Zero Voltage and Random Turn-On Switching
- DIN Rail & Panel Mount
- Status Indicating LED
- DC or AC Control
- Integrated Overvoltage Protection by Automatic Self Turn-On (Suffix P)

Featuring state-of-the-art Surface Mount Technology, these SPST-NO relays deliver proven reliability in the most demanding applications. Output consists of an SCR AC switch and is available in zero-cross or random turn-on versions. Manufactured in Crydom's ISO 9001 Certified facility for optimum product performance and reliability.

MODEL NUMBERS	CMRD2435 CMRA2435	CMRD2445 CMRA2445	CMRD2455 CMRA2455	CMRD2465 CMRA2465
OUTPUT SPECIFICATIONS ①				
Operating Voltage (47-63 Hz) [Vrms]	24-280	24-280	24-280	24-280
Max. Load Current @ 25°C Ambient Temperature [Arms]	35	45	55	65
Min. Load Current, [Arms]	0.15	0.15	0.25	0.25
Transient Overvoltage [Vpk]	600	600	600	600
Max. Surge Current, (16.6ms) [A _{pk}]	250	625	1000	1200
Max. On-State Voltage Drop @ Rated Current [Vpk]	1.6	1.6	1.6	1.6
Thermal Resistance Junction to Case (R _{qJC}) [°C/W]	1.02	0.63	0.31	0.28
Maximum I ² t for Fusing, (8.3 msec.) [A ² sec]	260	1620	4150	6000
Max. Off-State Leakage Current @ Rated Voltage [mArms]	10	10	10	10
Min. Off-State dv/dt @ Max. Rated Voltage [V/μsec] ②	500	500	500	500
Max. Turn-On Time ③	1/2 Cycle (DC Control), 10.0 msec (AC Control)			
Max. Turn-Off Time	1/2 Cycle (DC Control), 40.0 msec (AC Control)			
Power Factor (Min.) with Max. Load	0.5	0.5	0.5	0.5

INPUT SPECIFICATIONS ①	DC CONTROL	AC CONTROL
Control Voltage Range	3-32 Vdc	90-140 Vrms
Max. Reverse Voltage	32 Vdc	—
Max. Turn-On Voltage	3.0 Vdc	90 Vrms
Min. Turn-Off Voltage	1.0 Vdc	10 Vrms
Max. Input Current	30.0mA ④	—
Typical Input Current	17mA @ 5 Vdc	15mA @ 120 Vrms

GENERAL SPECIFICATIONS

Dielectric Strength 50/60Hz Input/Output/Base	4000 Vrms
Insulation Resistance (Min.) @ 500 Vdc	10 ⁹ Ohm
Max. Capacitance Input/Output	8 pF
Ambient Operating Temperature Range	-40 to 80°C
Ambient Storage Temperature Range	-40 to 125°C
Status Indicating Display	Green LED

MECHANICAL SPECIFICATIONS

Weight: (typical)	16.8 oz. (476g)
Encapsulation:	Thermally Conductive Epoxy
Terminals:	Cage Type
Maximum Wire Size- Output: AWG 8 (3.8mm) Input: AWG12 (2.5mm)	
Recommended Terminal Screw Torque Range:	
Output: 10-15 in lb (1.1-1.7 Nm)	
Input: 5-6 in lb (0.6-0.7 Nm)	

© 2007 CRYDOM Inc., Specifications subject to change without notice.

- ① All parameters at 25°C unless otherwise specified.
 ② Off-State dv/dt test method per EIA/NARM standard RS-443, paragraph 13.11.1
 ③ Turn-on time for DC control random turn-on versions is 0.02msec.
 ④ Input circuitry incorporates active current limiter.

CURRENT DERATING CURVES

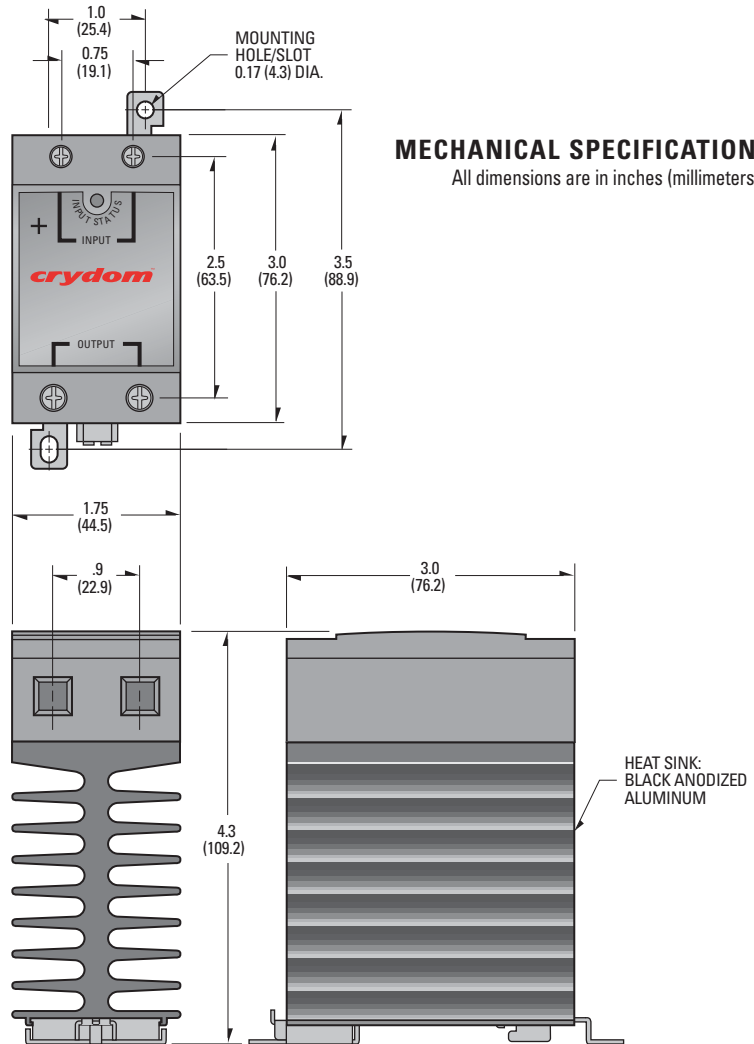
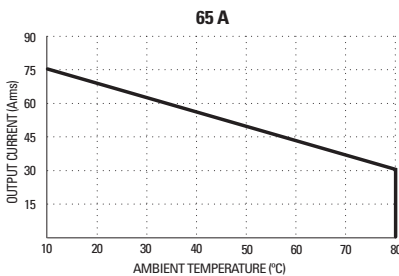
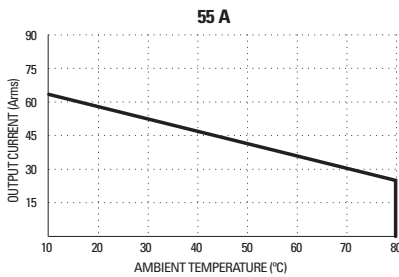
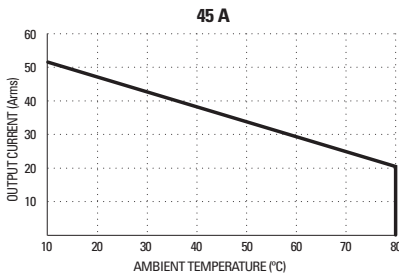
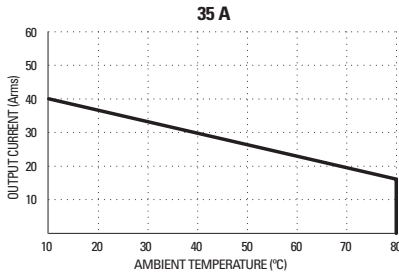

AVAILABLE OPTIONS

- 10 Random Turn-On, Phase Controllable
Example: **CMRD2435-10**
- E 24 Vac Input (18-36 Vac)
Example: **CMRA2435E**
- P Internal Overvoltage Protection
Relay Will Self Trigger Between
450-600 Vpk. Not Suitable For Capacitive Loads.
Example: **CMRD2435P**

APPROVALS

UL E116950
CSA LR81689
VDE 126921 UG



SERIES CMRD/CMRA.
Rev. 100107
PAGE 2 OF 7

© 2007 CRYDOM Inc., Specifications subject to change without notice.

For recommended applications and more information contact:
USA: Sales Support (877) 502-5500 **Tech Support** (877) 702-7700 FAX (619) 710-8540
 Crydom Inc., 2320 Paseo de las Americas, Ste. 201, San Diego, CA 92154
Email: sales@crydom.com **WEB SITE:** http://www.crydom.com
UK: +44 (0)1202 606030 • **FAX** +44 (0)1202 606035 Crydom SSR Ltd., Arena Business Centre,
 Holyrood Close, Poole, Dorset BH17 7FJ, Email: intsales@crydom.com.
GERMANY: +49 (0)180 3000 506



- Zero Voltage and Random Turn-On Switching
- DIN Rail & Panel Mount
- Status Indicating LED
- DC or AC Control
- Integrated Overvoltage Protection by Automatic Self Turn-On (Suffix P)

Featuring state-of-the-art Surface Mount Technology, these SPST-NO relays deliver proven reliability in the most demanding applications. Output consists of an SCR AC switch and is available in zero-cross or random turn-on versions.

Manufactured in Crydom's ISO 9001 Certified facility for optimum product performance and reliability.

MODEL NUMBERS	CMRD4835 CMRA4835	CMRD4845 CMRA4845	CMRD4855 CMRA4855	CMRD4865 CMRA4865
OUTPUT SPECIFICATIONS ①				
Operating Voltage (47-63 Hz) [Vrms]	48-530	48-530	48-530	48-530
Max. Load Current @ 25°C Ambient Temperature [Arms]	35	45	55	65
Min. Load Current, [Arms]	0.15	0.15	0.25	0.25
Transient Overvoltage [Vpk]	1200	1200	1200	1200
Max. Surge Current, (16.6ms) [Apk]	250	625	1000	1200
Max. On-State Voltage Drop @ Rated Current [Vpk]	1.7	1.7	1.7	1.7
Thermal Resistance Junction to Case (R _{qJC}) [° C/W]	1.02	0.63	0.31	0.28
Maximum I ² t for Fusing, (8.3 msec.) [A ² sec]	260	1620	4150	6000
Max. Off-State Leakage Current @ Rated Voltage [mArms]	10	10	10	10
Min. Off-State dv/dt @ Max. Rated Voltage [V/μsec] ②	500	500	500	500
Max. Turn-On Time ③	1/2 Cycle (DC Control), 10.0 msec (AC Control)			
Max. Turn-Off Time	1/2 Cycle (DC Control), 40.0 msec (AC Control)			
Power Factor (Min.) with Max. Load	0.5	0.5	0.5	0.5

INPUT SPECIFICATIONS ①	DC CONTROL	AC CONTROL
Control Voltage Range	4-32 Vdc	90-140 Vrms
Max. Reverse Voltage	32 Vdc	—
Max. Turn-On Voltage	4.0 Vdc	90 Vrms
Min. Turn-Off Voltage	1.0 Vdc	10 Vrms
Max. Input Current	30.0mA ④	—
Typical Input Current	14mA @ 5 Vdc	15mA @ 120 Vrms

GENERAL NOTES

- ① All parameters at 25° C unless otherwise specified.
 ② Off-State dv/dt test method per EIA/NARM standard RS-443, paragraph 13.11.1
 ③ Turn-on time for DC control random turn-on versions is 0.02msec.
 ④ Input circuitry incorporates active current limiter.

GENERAL SPECIFICATIONS

Dielectric Strength 50/60Hz Input/Output/Base	4000 Vrms
Insulation Resistance (Min.) @ 500 Vdc	10 ⁹ Ohm
Max. Capacitance Input/Output	8 pF
Ambient Operating Temperature Range	-40 to 80°C
Ambient Storage Temperature Range	-40 to 125°C
Status Indicating Display	Green LED

MECHANICAL SPECIFICATIONS

Weight: (typical)	16.8 oz. (476g)
Encapsulation:	Thermally Conductive Epoxy
Terminals:	Cage Type
Maximum Wire Size- Output: AWG 8 (3.8mm) Input: AWG12 (2.5mm)	
Recommended Terminal Screw Torque Range:	
	Output: 10-15 in lb (1.1-1.7 Nm)
	Input: 5-6 in lb (0.6-0.7 Nm)

© 2007 CRYDOM Inc., Specifications subject to change without notice.

CURRENT DERATING CURVES

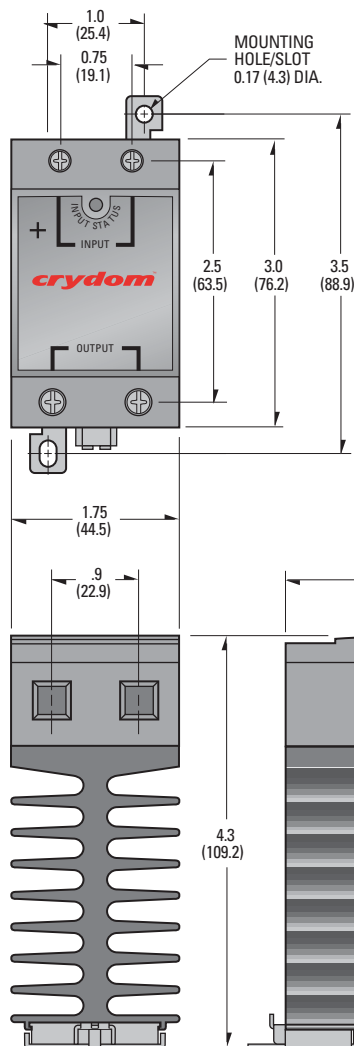
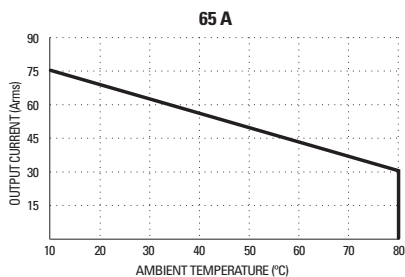
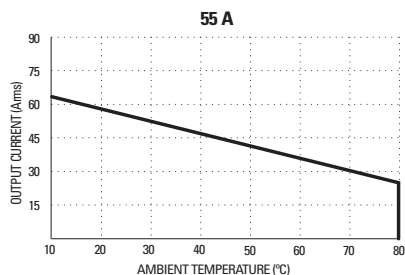
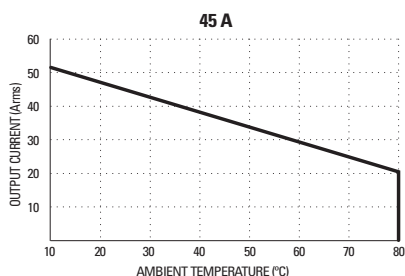
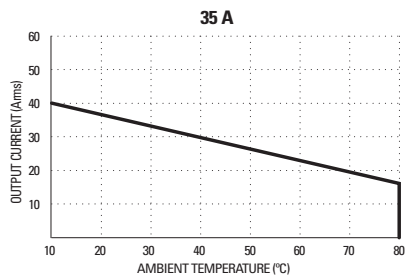

MECHANICAL SPECIFICATIONS

All dimensions are in inches (millimeters)

HEAT SINK:
BLACK ANODIZED
ALUMINUM

AVAILABLE OPTIONS

- 10 Random Turn-On, Phase Controllable
Example: **CMRD4835-10**
- E 24 Vac Input (18-36 Vac)
Example: **CMRA4835E**
- P Internal Overvoltage Protection.
Relay Will Self Trigger Between
900-1200Vpk. Not suitable For Capacitive Loads.
Example: **CMRD4835P**

APPROVALS

UL E116950
CSA LR81689
VDE 126921 UG



SERIES CMRD/CMRA.
Rev. 100107
PAGE 4 OF 7

© 2007 CRYDOM Inc., Specifications subject to change without notice.

For recommended applications and more information contact:
USA: Sales Support (877) 502-5500 **Tech Support** (877) 702-7700 FAX (619) 710-8540
 Crydom Inc., 2320 Paseo de las Americas, Ste. 201, San Diego, CA 92154
Email: sales@crydom.com **WEB SITE:** http://www.crydom.com
UK: +44 (0)1202 606030 • **FAX** +44 (0)1202 606035 Crydom SSR Ltd., Arena Business Centre,
 Holyrood Close, Poole, Dorset BH17 7FJ, Email: intsales@crydom.com.
GERMANY: +49 (0)180 3000 506



- Zero Voltage and Random Turn-On Switching
- DIN Rail & Panel Mount
- Status Indicating LED
- DC or AC Control
- Integrated Overvoltage Protection by Automatic Self Turn-On (Suffix P)

Featuring state-of-the-art Surface Mount Technology, these SPST-NO relays deliver proven reliability in the most demanding applications. Output consists of an SCR AC switch and is available in zero-cross or random turn-on versions.

Manufactured in Crydom's ISO 9001 Certified facility for optimum product performance and reliability.

MODEL NUMBERS	CMRD6035 CMRA6035	CMRD6045 CMRA6045	CMRD6055 CMRA6055	CMRD6065 CMRA6065
OUTPUT SPECIFICATIONS ①				
Nominal Line Voltage ($\pm 10\%$) [Vrms]	600	600	600	600
Operating Voltage (47-63 Hz) [Vrms]	48-660	48-660	48-660	48-660
Max. Load Current @ 25°C Ambient Temperature [Arms]	35	45	55	65
Min. Load Current, [Arms]	0.15	0.15	0.25	0.25
Transient Overvoltage [Vpk]	1200	1200	1200	1200
Max. Surge Current, (16.6ms) [Apk]	250	625	1000	1200
Max. On-State Voltage Drop @ Rated Current [Vpk]	1.7	1.7	1.7	1.7
Thermal Resistance Junction to Case (R_{qJC}) [°C/W]	1.02	0.63	0.31	0.28
Maximum $I^2 t$ for Fusing, (8.3 msec.) [A ² sec]	260	1620	4150	6000
Max. Off-State Leakage Current @ Rated Voltage [mArms]	1.0	1.0	1.0	1.0
Min. Off-State dv/dt @ Max. Rated Voltage [V/ μ sec] ②	500	500	500	500
Max. Turn-On Time ③	1/2 Cycle (DC Control), 10.0 msec (AC Control)			
Max. Turn-Off Time	1/2 Cycle (DC Control), 40.0 msec (AC Control)			
Power Factor (Min.) with Max. Load	0.5	0.5	0.5	0.5

INPUT SPECIFICATIONS ①	DC CONTROL	AC CONTROL
Control Voltage Range	4-32 Vdc	90-140 Vrms
Max. Reverse Voltage	32 Vdc	—
Max. Turn-On Voltage	4.0 Vdc	90 Vrms
Min. Turn-Off Voltage	1.0 Vdc	10 Vrms
Max. Input Current	30.0mA ④	—
Typical Input Current	14mA @ 5 Vdc	15mA @ 120 Vrms

GENERAL SPECIFICATIONS

Dielectric Strength 50/60Hz Input/Output/Base	4000 Vrms
Insulation Resistance (Min.) @ 500 Vdc	10 ⁹ Ohm
Max. Capacitance Input/Output	8 pF
Ambient Operating Temperature Range	-40 to 80°C
Ambient Storage Temperature Range	-40 to 125°C
Status Indicating Display	Green LED

MECHANICAL SPECIFICATIONS

Weight: (typical)	16.8 oz. (476g)
Encapsulation:	Thermally Conductive Epoxy
Terminals:	Cage Type
Maximum Wire Size- Output: AWG 8 (3.8mm) Input: AWG12 (2.5mm)	
Recommended Terminal Screw Torque Range:	
Output: 10-15 in lb (1.1-1.7 Nm)	
Input: 5-6 in lb (0.6-0.7 Nm)	

© 2007 CRYDOM Inc., Specifications subject to change without notice.

GENERAL NOTES

- ① All parameters at 25° C unless otherwise specified.
- ② Off-State dv/dt test method per EIA/NARM standard RS-443, paragraph 13.11.1
- ③ Turn-on time for DC control random turn-on versions is 0.02msec.
- ④ Input circuitry incorporates active current limiter.

For recommended applications and more information contact:

USA: Sales Support (877) 502-5500 Tech Support (877) 702-7700 FAX (619) 710-8540

Crydom Inc., 2320 Paseo de las Americas, Ste. 201, San Diego, CA 92154

Email: sales@crydom.com WEB SITE: <http://www.crydom.com>

UK: +44 (0)1202 606030 • FAX +44 (0)1202 606035 Crydom SSR Ltd., Arena Business Centre, Holyrood Close, Poole, Dorset BH17 7FJ, Email: intsales@crydom.com.

GERMANY: +49 (0)180 3000 506

crydom™ Series **CMRD/CMRA60**

35-65Amp • 600 Vac - AC OUTPUT

CURRENT DERATING CURVES

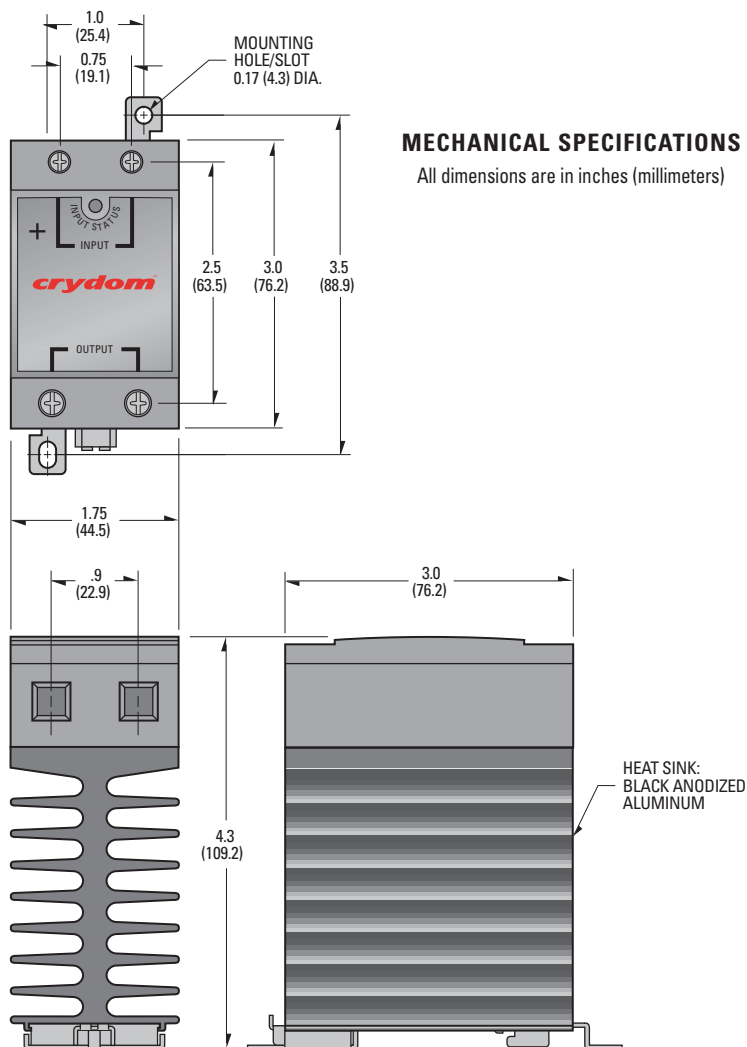
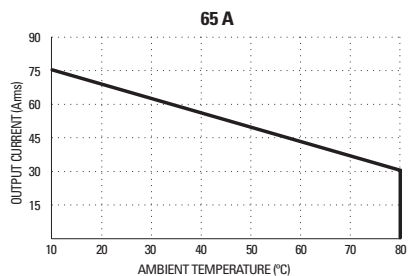
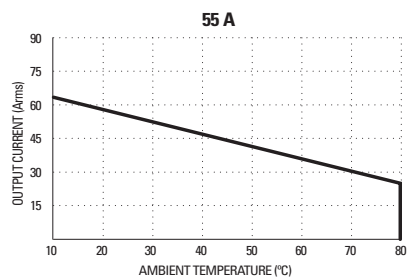
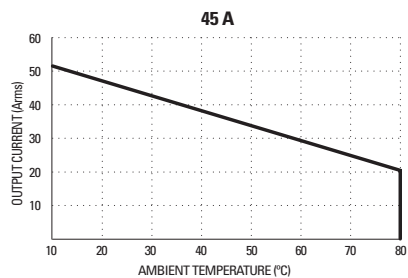
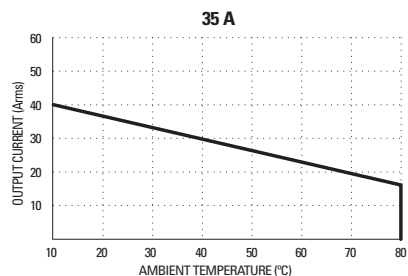

AVAILABLE OPTIONS

- 10 Random Turn-On, Phase Controllable
Example: **CMRD6035-10**
- E 24 Vac Input (18-36 Vac)
Example: **CMRA6035E**
- P Internal Overvoltage Protection.
Relay Will Self Trigger Between 900-1200Vpk. Not Suitable For Capacitive Loads.
Example: **CMRD6035P**

© 2007 CRYDOM Inc., Specifications subject to change without notice.

APPROVALS

UL E116950
 CSA LR81689
 VDE 126921



SERIES CMRD/CMRA.
 Rev. 100107
 PAGE 6 OF 7

For recommended applications and more information contact:
USA: Sales Support (877) 502-5500 **Tech Support** (877) 702-7700 FAX (619) 710-8540
 Crydom Inc., 2320 Paseo de las Americas, Ste. 201, San Diego, CA 92154
Email: sales@crydom.com **WEB SITE:** http://www.crydom.com
UK: +44 (0)1202 606030 • **FAX** +44 (0)1202 606035 Crydom SSR Ltd., Arena Business Centre,
 Holyrood Close, Poole, Dorset BH17 7FJ, Email: intsales@crydom.com.
GERMANY: +49 (0)180 3000 506



**DANGER / PELIGRO / DANGER /GEFAHR / PERICOLO / PERIGO**

<p>HAZARD OF ELECTRIC SHOCK, EXPLOSION, OR ARC FLASH.</p> <ul style="list-style-type: none"> • Disconnect all power before installing or working with this equipment. • Verify all connections and replace all covers before turning on power. <p>Failure to follow these instructions will result in death or serious injury.</p>	<p>RIESGO DE DESCARGA ELECTRICA O EXPLOSION.</p> <ul style="list-style-type: none"> • Desconectar todos los suministros de energia a este equipo antes de trabajar con este equipo. • Verificar todas las conexiones y colocar todas las tapas antes de energizar el equipo. <p>El incumplimiento de estas instrucciones puede provocar la muerte o lesiones serias.</p>	<p>RISQUE DE DESCARGE ELECTRIQUE OU EXPLOSION</p> <ul style="list-style-type: none"> • Eteindre toutes les sources d'énergie de cet appareil avant de travailler dessus de cet appareil • Vérifier tous connections, et remettre tous couverts en place avant de mettre sous <p>De non-suivi de ces instructions provoquera la mort ou des lésions sérieuses.</p>	<p>GEFAHR EINES ELEKTRISCHEN SCHLAGES ODER EINER EXPLOSION.</p> <ul style="list-style-type: none"> • Stellen Sie jeglichen Strom ab, der dieses Gerät versorgt, bevor Sie an dem Gerät Arbeiten durchführen • Vor dem Drehen auf Energie alle Anschlüsse überprüfen und alle Abdeckungen ersetzen. <p>Unterlassung dieser Anweisungen können zum Tode oder zu schweren Verletzungen führen.</p>	<p>RISCHIO DI SCOSSA ELETTRICA O DELL'ESPLOSIONE.</p> <ul style="list-style-type: none"> • Spenga tutta l'alimentazione e che fornisce questa apparecchiatura prima del lavorare a questa apparecchiatura • Verificare tutti i collegamenti e sostituire tutte le coperture prima della rotazione sull'alimentazione <p>L'omissione di seguire queste istruzioni provocherà la morte o di lesioni serie</p>	<p>RISCO DE DESCARGA ELÉTRICA OU EXPLOÇÃO</p> <ul style="list-style-type: none"> • Desconectar o equipamento de toda a energia antes de instalar ou trabalhar com este equipamento • Verificar todas as conexões e recolocar todas as tampas antes de religar o equipamento <p>O não cumprimento destas instruções pode levar à morte ou lesões sérias.</p>
--	--	---	---	---	---

**WARNING / AVERTISSEMENT / WARNUNG / ADVERTENCIA / AVVERTENZA / AVISO**

<p>RISK OF MATERIAL DAMAGE AND HOT ENCLOSURE</p> <ul style="list-style-type: none"> • The product's side panels may be hot, allow time for product to cool before touching. • Follow proper mounting instructions including torque values. • Do not allow liquids or foreign objects to enter this product. <p>Failure to follow this instruction can result in serious injury, or equipment damage.</p>	<p>RISQUE DE DOMMAGE MATERIEL ET DE SURCHAUFFE DU BOITIER</p> <ul style="list-style-type: none"> • Les panneaux latéraux du produit peuvent être chauds. Laisser le produit refroidir avant de le toucher. • Respecter les consignes de montage, et notamment les couples de serrage. • Ne pas laisser pénétrer de liquide ni de corps étrangers à l'intérieur du produit. <p>Le non-respect de cette directive peut entraîner, des lésions corporelles graves ou des dommages matériels.</p>	<p>GEFAHR VON MATERIALSCHÄDEN UND GEHÄUSEERHITZUNG</p> <ul style="list-style-type: none"> • Die Seitenwände können heiß sein. Lassen Sie das Produkt abkühlen, bevor Sie es berühren. • Beachten Sie die Montageanweisungen, • Führen Sie keine Flüssigkeiten oder Fremdkörper in das Produkt ein. <p>Die Nichtbeachtung dieser Anweisung kann Körperverletzung oder Materialschäden zur Folge haben.</p>
<p>RIESGO DE DAÑOS MATERIALES Y DE SOBRECIENTAMIENTO DE LA UNIDAD</p> <ul style="list-style-type: none"> • Los paneles laterales del producto pueden estar calientes. Esperar que el producto se enfríe antes de tocarlo. • Respetar las instrucciones de montaje, y en particular los pares de apretado. • No dejar que penetren líquidos o cuerpos extraños en el producto. <p>Si no se respetan estas precauciones pueden producirse graves lesiones, daños materiales.</p>	<p>RISCHIO DI DANNI MATERIALI E D'INVOLUCRO CALDO</p> <ul style="list-style-type: none"> • I pannelli laterali dell'apparecchio possono scottare; lasciar quindi raffreddare il prodotto prima di toccarlo. • Seguire le istruzioni di montaggio corrette. • Non far entrare liquidi o oggetti estranei in questo apparecchio. <p>La mancata osservanza di questa precauzione può causare gravi rischi per l'incolumità personale o danni alle apparecchiature.</p>	<p>RISCO DE DANO MATERIAL E DE AQUECIMENTO</p> <ul style="list-style-type: none"> • Os painéis laterais do produto podem estar quentes; dê tempo ao produto para arrefecer antes de lhe tocar. • Siga devidamente as instruções de montagem. • Não permita a entrada de líquidos e de objectos estranhos no produto. <p>A não observância destas precauções pode provocar a morte, ferimentos graves ou danos materiais.</p>

ANNEX – ENVIRONMENTAL INFORMATION:

The environmental information disclosed in this annex including the EIP Pollution logo are in compliance with People's Republic of China Electronic Industry Standard SJ/T11364 – 2006, Marking for Control of Pollution Caused by Electronic Information Products.

Part Name	Toxic or hazardous Substance and Elements					
	Lead (Pb)	Mercury (Hg)	Cadmium (Cd)	Hexavalent Chromium (Cr (VI))	Polybrominated biphenyls (PBB)	Polybrominated diphenyl ethers (PBDE)
Semiconductor die	X	O	O	O	O	O
Solder	X	O	O	O	O	O

附件 - 环保信息:

此附件所标示的包括电子信息产品污染图标的环保信息符合中华人民共和国电子行业标准 **SJ/T11364 - 2006**, 电子信息产品污染控制标识要求

部件名称	有毒有害物质或元素					
	铅 (Pb)	汞 (Hg)	镉 (Cd)	六价铬 (Cr (VI))	多溴联苯 (PBB)	多溴二苯醚 (PBDE)
半导体芯片	X	O	O	O	O	O
焊接点	X	O	O	O	O	O

